

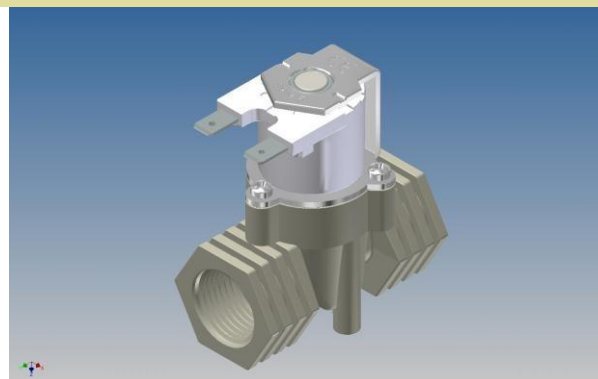

Connexion Developments Ltd
 Unit 3, Rainbow Court Armstrong Way
 Yate, Bristol, BS37 5NG, England
 Tel. +44 (0) 1454 334 990
 Fax +44 (0) 1454 326 390
www.solenoid-valve.world

Elettrovalvola Serie R Mini

R Mini -510



CLASSIFICAZIONE

Tipologia	Semplice
Geometria	180°

CARATTERISTICHE DI LAVORO

Pressione di esercizio	0,2 ÷ 10 bar
Temperatura ambiente	0 ÷ 60°C
Temperatura fluido	25°C; 60°C; 90°C
Ciclo di lavoro	ED 100%; ED 60%(90°C)
Direzione del fluido	Unidirezionale
Diametro di passaggio	DN 11 mm
Comando	Bistabile; NA; NC

CARATTERISTICHE FISICHE

Corpo valvola	PA 6,6 30% fibra vetro
Membrane e guarnizioni	EPDM; NBR (buna); Silicone (MVQ)
Nucleo	Acciaio INOX
Molla	Acciaio INOX
Assemblaggio	Con viti ispezionabile

CONNESSIONI IDRAULICHE

Connessioni in ingresso	Filetto BSP (GAS) 1/2" F
Connessioni in uscita	Filetto BSP (GAS) 1/2" F

CONNESSIONI ELETTRICHE

Connessioni elettriche 1	Faston Maschio 6,3 x 0,8 mm
Connessioni elettriche 2	Cavi unipolari max 5 m
Connessioni elettriche 3	Cavi bipolari max 5 m

APPLICAZIONI

Ovunque necessario il controllo automatico dell'acqua. Carico H2O caldaie piccolo elettrodomestico e impianti filtrazione, Frigoriferi, Macchine ghiaccio, Distributori acqua, Forni, Rubinetti, Idromassaggi, Macchine caffè, Irrigazione e Idropultrici.

CLASSIFICATION

Type	Single
Geometria	180°

WORKING SPECIFICATIONS

Working pressure	0,2 ÷ 10 bar
Room temperature	0 ÷ 60°C
Fluid temperature	25°C; 60°C; 90°C
Duty cycle	ED 100%; ED 60%(90°C)
Flow direction	Unidirectional
Nominal diameter	DN 11 mm
Control	Latching; NC; NO

PHYSICAL SPECIFICATIONS

Valve body	PA 6,6 30% fiber glass
Diaphragms gasket	EPDM; NBR (buna); Silicone (MVQ)
Core	Stainless Steel
Spring	Stainless Steel
Assembly	With screws for inspection

HYDRAULIC CONNECTIONS

Inlet	1/2" BSP Female thread
Outlet	1/2" BSP Female thread

ELECTRICAL CONNECTIONS

Electric connect 1	Male Faston 6,3 x 0,8 mm
Electric connect 2	Unipolar cables max 5 m
Electric connect 3	Bipolar cables max 5 m

APPLICATIONS

Wherever automatic water control is needed. Water filling in small boiler and in filtration plants, Refrigerators, Ice machines, Water dispensers, Industrial ovens, Taps, Hydromassage, Coffee makers, Irrigation, High pressure jet machine.

MARCHI E APPROVAZIONI / CERTIFICATION MARKS



Revisione Rev 0

20/05/11

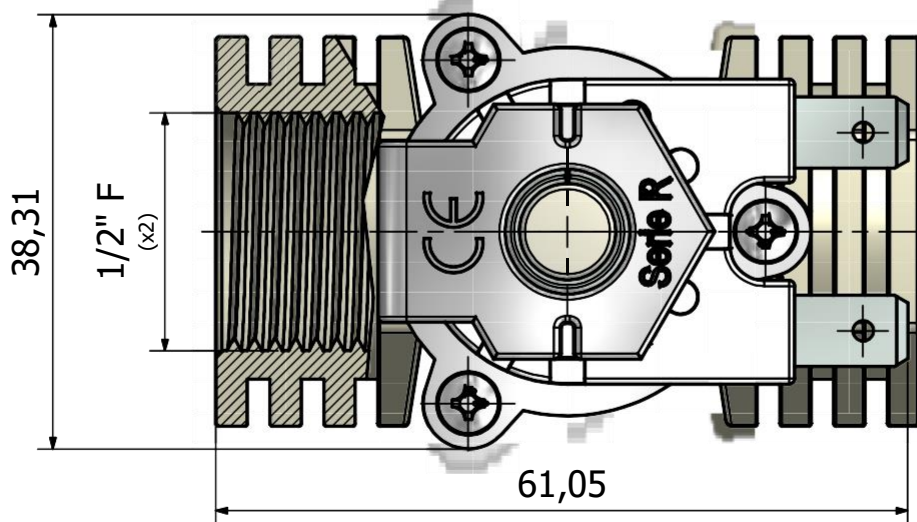
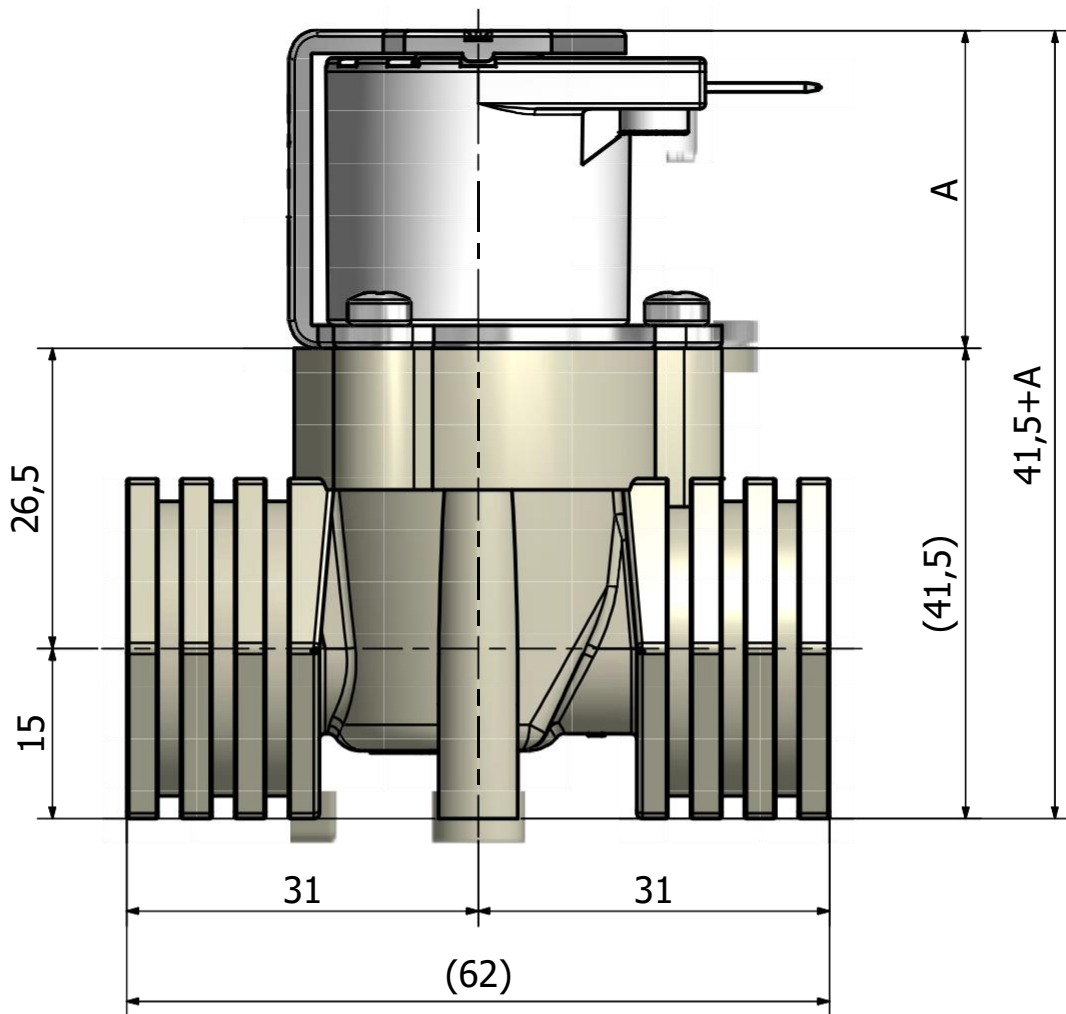

Dimension A (mm)

Normalmente chiusa con faston <i>Normally closed with faston</i>	28
Normalmente chiusa con cavi <i>Normally closed with cable</i>	29,2
Normalmente aperta <i>Normally open</i>	47,2
Bistabile <i>Latching</i>	38,3



R Mini -510

Serie:

R Mini



Data: 11/04/2011
Revisione: